



WEY G9

FIRST CLASS FOR ALL



For More Information



GWM Malaysia



gwm.com.my



Customer Service Hotline
1800 18 2882



Email
support@gwm.com.my

Notice

The specifications, product information, or images displayed herein are for illustration purposes. Some of the product and service information, illustrations, and images contained herein may have been prepared for generic use and the actual products may vary from those displayed herein, owing to technical limitations.

The illustrations may show accessories, optional equipment, or other features which are not part of the standard specification or service scope available in Malaysia. The company reserves the right to change all information, specifications, and grades without prior notice. For safety and efficiency in use, please refer to the manual before use. The company shall not be responsible for discrepancies or differences between the illustrations displayed for specification and standard equipment and the actual product.

First Class, Redefined For Everyone

Named after its founder, GWM WEY is built on a clear promise: to put people first and engineer safety into every detail. Through global-standard craftsmanship, intelligent technology and a user-first mindset, GWM WEY turns everyday journeys into experiences that feel quieter, safer and more refined.

This is first class, made accessible.
First Class for All.



"In China's history, many great brands have carried their founder's name. It stands for accountability and courage, and for true credibility. That is why I gave my own name to WEY."
— Jack Wey, Chairman of GWM



Inspired By Nature, Designed For First Class

Inspired by the philosophy of “High Mountains and Flowing Water”, the GWM WEY G9 Hi4 PHEV brings this poetic concept to life through its design. Its waterfall-inspired front grille, mountain-like silhouette and bamboo-inspired taillights blend Eastern natural beauty with contemporary luxury for the age of intelligent mobility.



Mountain Silhouette

The strong side profile evokes the stability of mountain peaks, harmonising safety, robustness and aerodynamic efficiency.



Waterfall Grille

The front grille features a cascading waterfall design, creating a powerful yet refined presence.



Bamboo Taillights

Inspired by the layered rhythm and shifting light of bamboo forests, the taillight design conveys elegance, dynamism and natural harmony.

First Class Driving Powered By Hi4 Technology



More Efficient. More Thrilling. More Secure.

442 PS Maximum Combined Power	642 N·m Maximum Combined Torque	5.7 s 0-100 km/h
---	---	----------------------------



Powered by GWM's innovation in powertrain architecture, the GWM WEY G9 Hi4 PHEV combines a 1.5 L turbocharged engine, 4-speed DHT, and front-and-rear dual electric motors to deliver a "3 Power Units, 9 Modes" all-scenario operating system. With intelligent, seamless self-adaptive switching, it balances strong performance and outstanding efficiency, ensuring optimal efficiency and confident driving across all conditions.

Power Modes

EV Mode

EV Priority Mode

Intelligent HEV Mode



44.2 kWh
Battery Capacity

170 km
Pure Electric Driving
Range (NEDC)

1,000 km+
Combined Driving
Range (NEDC)

1.2 L
Fuel Consumption
(NEDC)

6.2 L
Fuel Consumption at
Low State of Charge

Exclusive MPV Tuning, Made For Malaysian Roads



Outstanding Stability Across All Road Conditions

50:50 Front-to-rear
Weight Distribution

iTVC Intelligent Torque
Vectoring Control | 0 : 100%-100% : 0
Dynamic Torque Distribution



Exclusive MPV suspension tuning, tailored for Malaysian roads to deliver confident handling and excellent comfort.

Full-aluminium
Suspension System

Five-link Rear
Suspension

Hydraulic Rebound Stop
(HRS) Technology

Driving Modes



Normal Mode

The balanced choice for most days. Smooth power delivery and stable handling give you confident performance in most road conditions.



Eco Mode

Prioritises fuel efficiency and a relaxed response. Ideal for family trips and city traffic when comfort and range matter more than speed.



Sport Mode

Sharpens throttle response for quicker acceleration and more dynamic performance. Perfect for open roads when you want a more spirited drive.



AWD Mode

Maximises traction on wet, muddy, or uneven surfaces. Utilises the four-wheel drive system to help you tackle hills and rougher roads with confidence.



Snow Mode

Softens power delivery and improves stability on low-grip surfaces. Helps the vehicle stay composed on slippery or uneven roads.

First Class Comfort, For Every Generation

First class comfort starts the moment you step inside.

The GWM WEY G9 Hi4 PHEV is thoughtfully designed so children and elderly family members can enter and exit with ease. Wide-opening doors and low step-in height minimise awkward climbing and bending, making every step feel natural and secure.

Once inside, the flexible common rail system and spacious walk-through space make it simple to buckle in the kids, and move between rows. This quiet, considered kind of comfort that transforms everyday family trips into calmer, safer, and more enjoyable journeys.

2nd & 3rd Row Flexible Common Rail System
Provides flexible cargo capacity ranging from 233 L to 1,725 L.

1,350 mm Tall Door Height
Allows natural, upright entry.

Flat Floor Design
Creates a smooth, level walkway for easier movement across the cabin.

370 mm Low Step-in Height
Makes getting in and out easy for all ages.

791 mm Extra-wide Door Opening
Designed for effortless entry and exit.



Dual-level B Pillar Handles



233 L - 1,725 L
Flexible Luggage Space

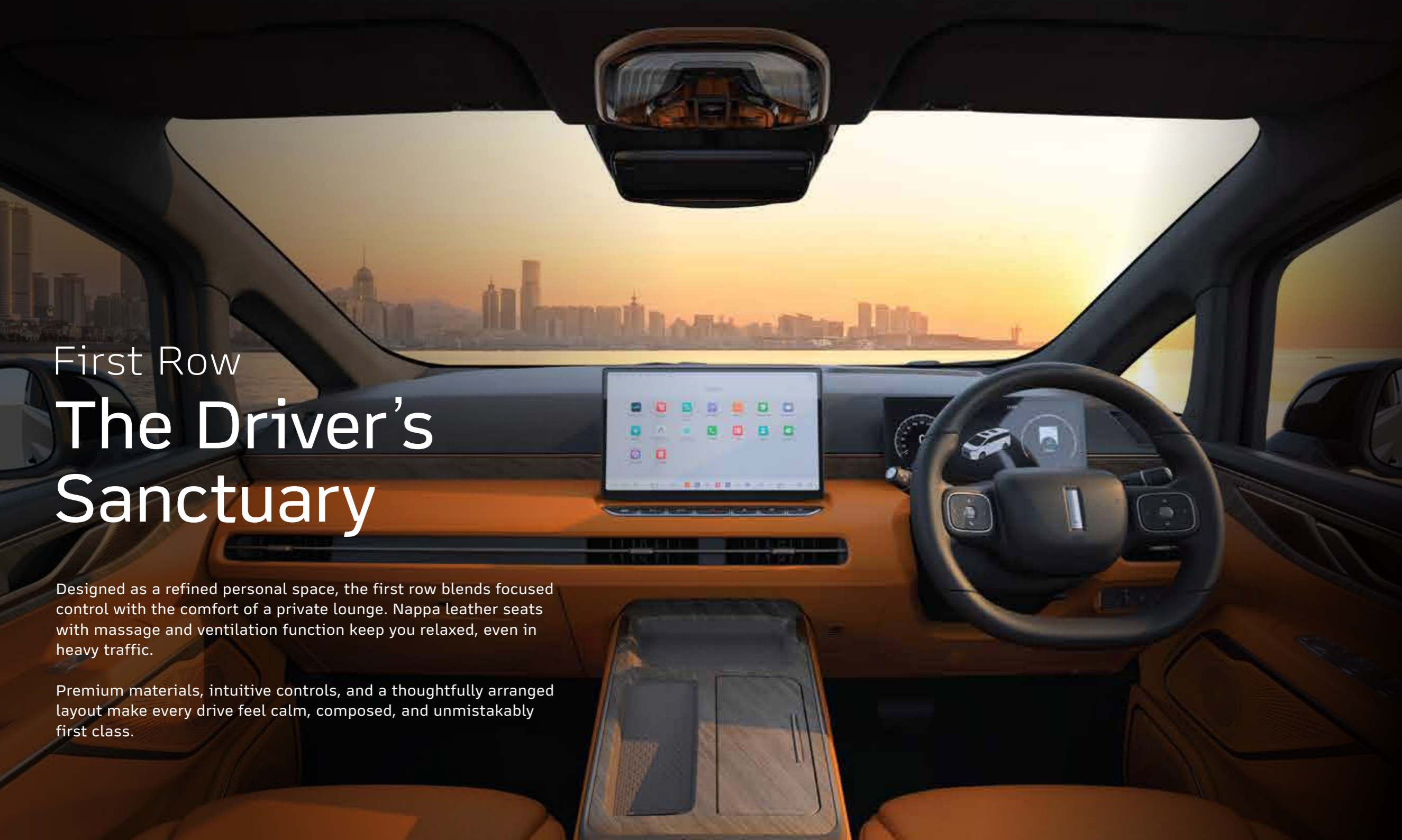

First Row The Driver's Sanctuary

Designed as a refined personal space, the first row blends focused control with the comfort of a private lounge. Nappa leather seats with massage and ventilation function keep you relaxed, even in heavy traffic.

Premium materials, intuitive controls, and a thoughtfully arranged layout make every drive feel calm, composed, and unmistakably first class.

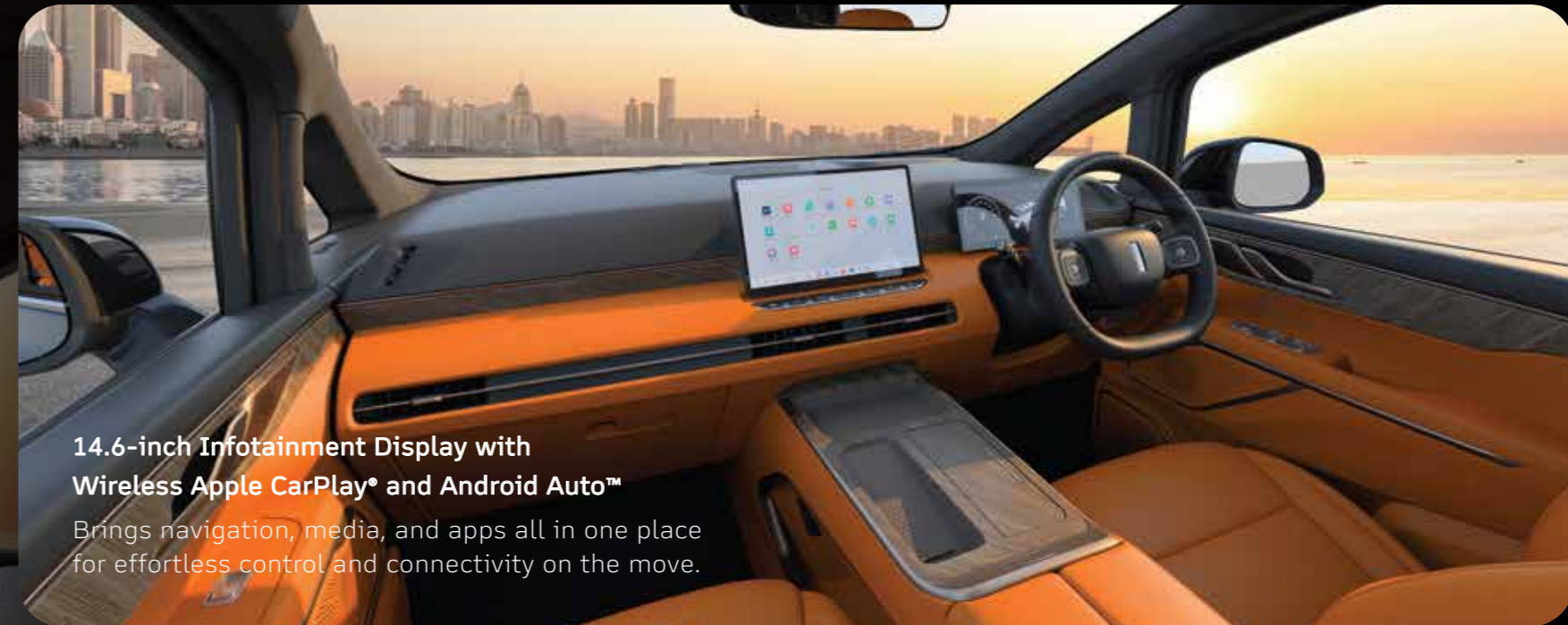

14.6-inch Infotainment Display with Wireless Apple CarPlay® and Android Auto™

Brings navigation, media, and apps all in one place for effortless control and connectivity on the move.



50 W Wireless Charger

Keeps your devices powered and charges quickly, no cables needed.

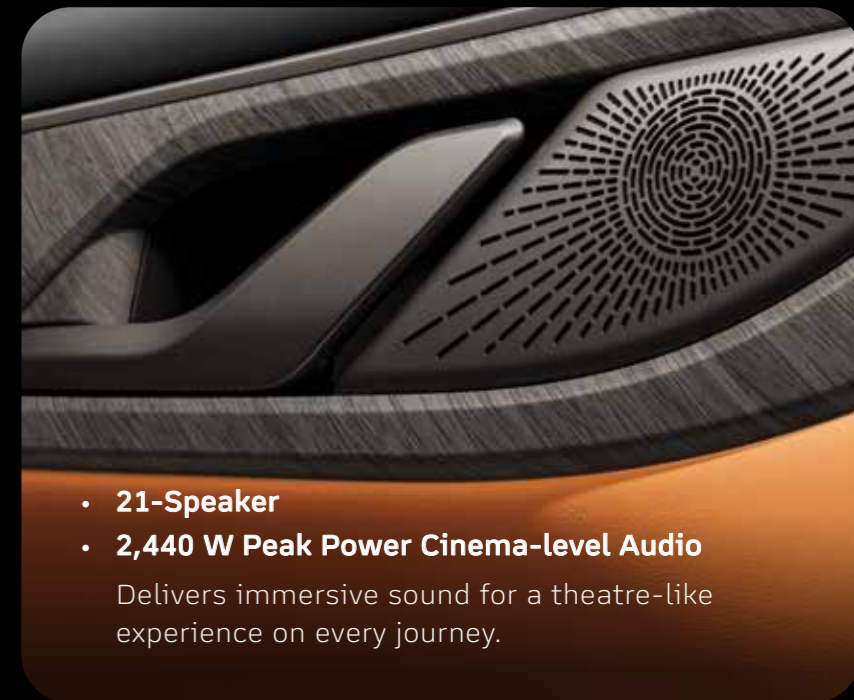

- **21-Speaker**
- **2,440 W Peak Power Cinema-level Audio**

Delivers immersive sound for a theatre-like experience on every journey.

Second Row The Passenger Lounge

The second row is designed as a true passenger lounge, where every journey feels calmer and more enjoyable. Generous space and thoughtful comfort invite passengers to relax and unwind.

Zero Gravity Seats support natural posture, while cinema-quality audio and a built-in smart fridge complete the first class experience, turning every journey into a moment of luxurious comfort.

- **Nappa Leather Zero Gravity Seats**
- **10-point Massage**
- **Seat Ventilation**

Support the body's natural posture for a more relaxed, pressure-free ride.

Seatback Folding Tray Table

Provide convenient space for work, play or refreshments on the move.

Seat Integrated Control Panel

Seating positions and massage settings can be effortlessly adjusted with just a single touch.

Double Opening Cold and Warm Refrigerator (0~50 °C)

Keeps drinks and snacks hot or cold for up to 24 hours.

Third Row The Family Sofa

The GWM WEY G9 Hi4 PHEV offers a truly comfortable third row, designed for adults and growing families alike. Spacious proportions and multi-layer cushioning transform the space into a genuine family sofa, inviting passengers to sit back and relax.

The flexible layout can easily adapt the third row between family seating and extra cargo space. Whether it's children resting, adults relaxing, or luggage being stored, it's designed to support all your needs.

1,290 mm

512 mm

151 mm Plush Seat Base

Balanced cushioning that comfortably supports passengers of all ages.

1,290 mm Extra-wide Third Row Sofa

Spacious seating that allows passengers to sit naturally and relax.

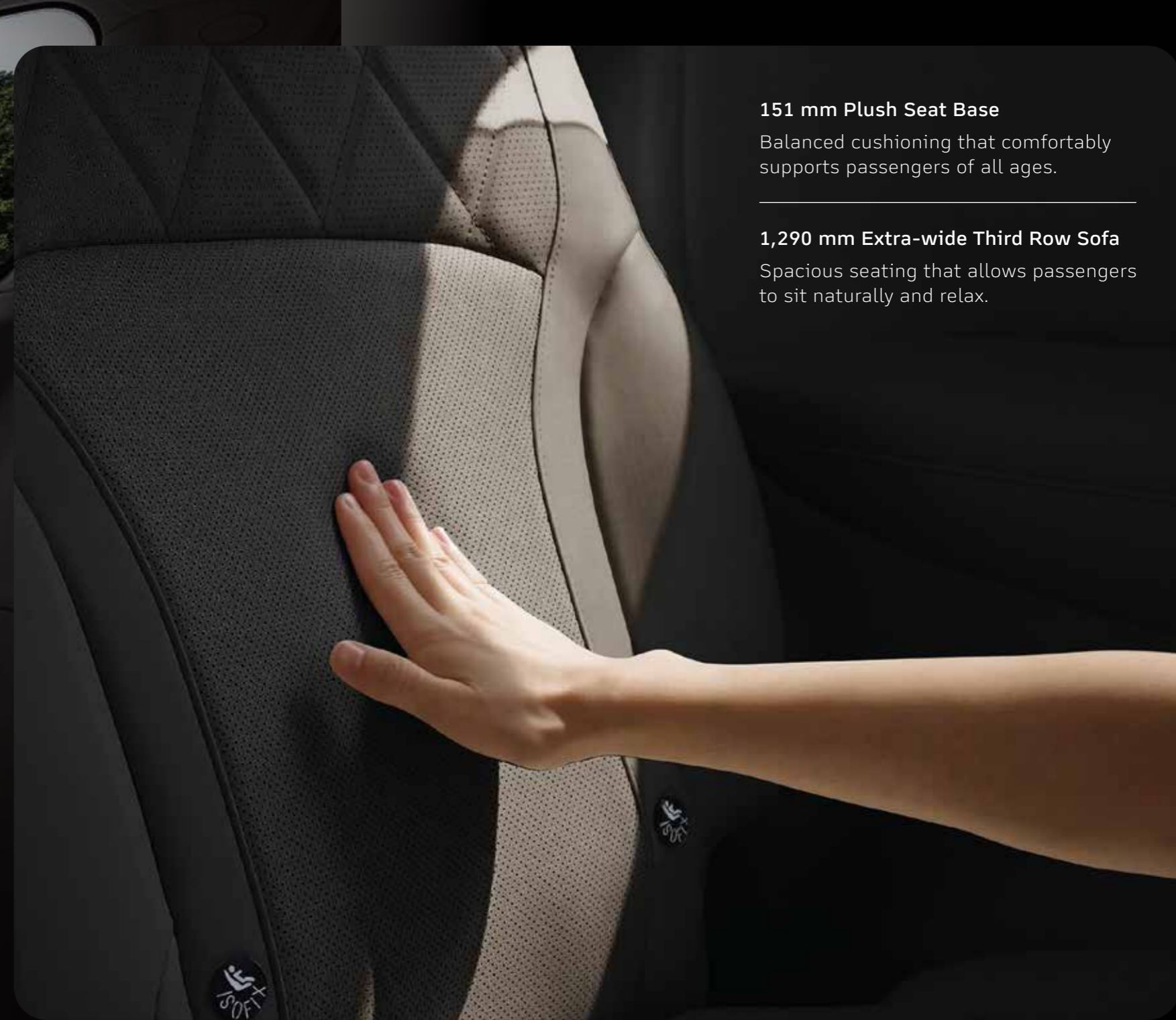

First Class Safety, For Every Member

True safety is built quietly into every detail. From the strength of its structure to the care taken inside the cabin, the GWM WEY G9 Hi4 PHEV is designed to protect what matters most—giving every passenger confidence, comfort and peace of mind on every journey.

12-Ton
Roof Pressure
Resistance

2,000 MPa
High Strength Steel
at A&B Pillar

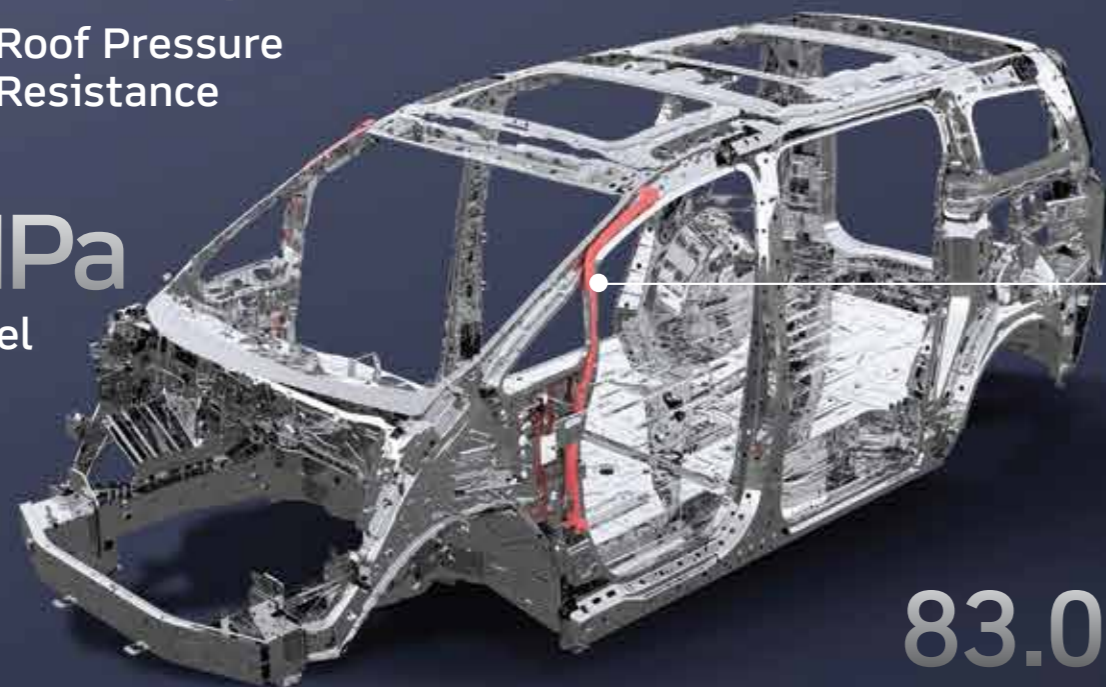

1,500 MPa
Hot-stamped Tube

83.01%
Full-vehicle High Strength
Materials Proposition

Fresh-air Cabin System



Triple Protection Air Cabin Purifier for All

Plasma Air Purifier

Reduces dust, bacteria and odours to maintain a fresh cabin environment.

Intelligent AQS Cabin Purification

Continuously monitors air quality and automatically adjusts airflow for optimal comfort.

CN95 Air Filter

Effectively filters PM2.5, droplets, bacteria, and other harmful particles with over 95% filtration efficiency.

Structural Protection



3,107 mm Side Air Curtains 6-second Pressure-retaining

Extended coverage across all three rows for enhanced side-impact protection.



Side 4-layer + Bottom 6-layer Battery Protection

Multi-layer battery protection reduces the risk of damage, overheating and leakage.



4-longitudinal, 7-transverse Main Cross-section Structure

Reinforced chassis design improves rigidity, stability and energy absorption.

For Situations That Demand First Class Safety

The GWM WEY G9 Hi4 PHEV is designed to make everyday driving safer and easier. Its active safety system helps prevent accidents, reduce driving stress, and support the driver in busy city traffic, long highway journeys, and tight parking situations.

With L2 ADAS working quietly in the background, The GWM WEY G9 Hi4 PHEV delivers peace of mind for families, making every journey safer, more relaxed, and more reassuring.



Digital Rearview Mirror with Automatic Anti-glare Function

Provides a wider, clearer rear view while driving.



Fully Automated Integrated Parking

Makes parking effortless and more reassuring, even in confined spaces.

LEVEL 2 Advanced Driving Assistance Systems (ADAS)

ACC – Adaptive Cruise Control
TJA – Traffic Jam Assist
FCW – Front Collision Warning
MEB – Manoeuvre Emergency Braking
LDW – Lane Departure Warning
LKA – Lane Keeping Assist
LCK – Lane Center Keeping
ELK – Emergency Lane Keeping

AEBI – Auto Emergency Braking + Intersection
LCA – Lane Change Assistance
RCW – Rear Collision Warning
RCTA – Rear Cross Traffic Alert
RCTB – Rear Cross Traffic Braking
SCM – Second Collision Mitigation
BSD – Blind Spot Detection
HDC – Hill Descent Control

First Class Convenience For Your Lifestyle

Stay connected to your GWM WEY G9 Hi4 PHEV wherever you are. The GWM App gives you a clear overview of your vehicle and allows you to prepare the cabin before you even step inside. From checking vehicle status to managing comfort settings, everything is designed to feel ready when you return.

APPLICATION FEATURES



Sunroof Status



Lock Status



Door Status



Remote Seat Ventilation



Remote Window Control + Status



Tyre Temperature and Pressure Status



Vehicle Charging Status



Remote Air Conditioning Control + Status



Vehicle Location

SCAN TO
DOWNLOAD
THE APP

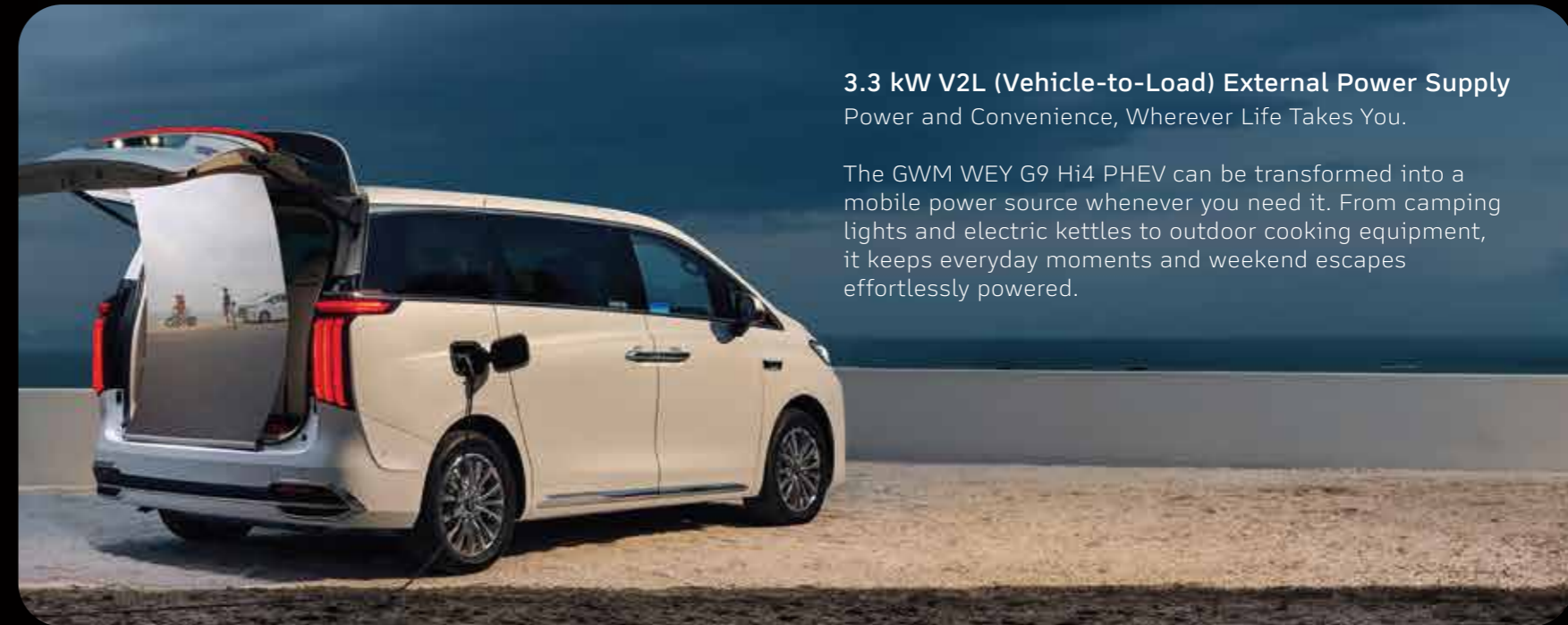

3.3 kW V2L (Vehicle-to-Load) External Power Supply Power and Convenience, Wherever Life Takes You.

The GWM WEY G9 Hi4 PHEV can be transformed into a mobile power source whenever you need it. From camping lights and electric kettles to outdoor cooking equipment, it keeps everyday moments and weekend escapes effortlessly powered.



63.4 dB(A) Quiet and Comfortable Cabin at 120 km/h

The vehicle is equipped with double-layer acoustic glass and 360° sound-absorbing materials, effectively reducing vibration and noise from all directions to deliver a quieter, more comfortable cabin experience in every journey.

Colour And Dimension

1,900 mm

1,985 mm

3,085 mm

5,050 mm

EXTERIOR COLOUR

Wisdom Grey



Aurora White



Nebula Black



INTERIOR COLOUR

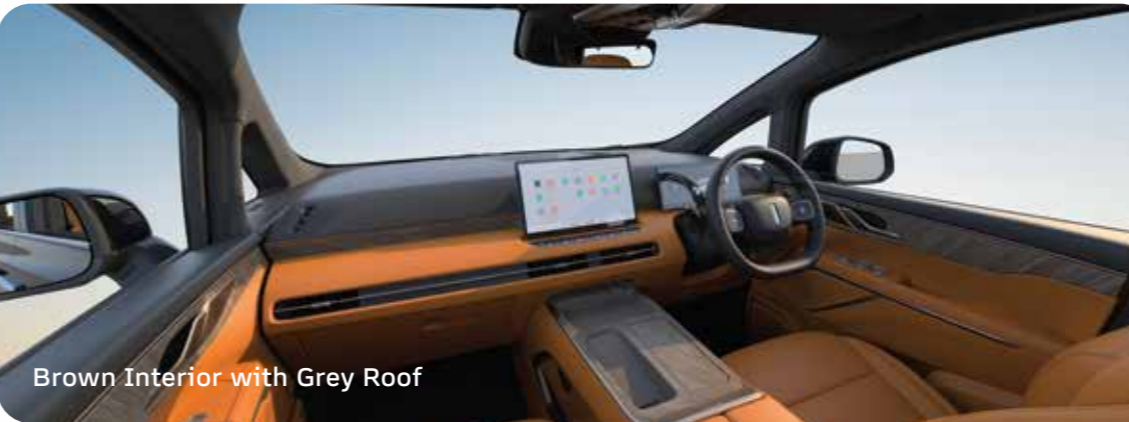

Brown Interior with Grey Roof



Black Interior with Grey Roof

WHEEL



18" Alloy Wheel

Model	GWM WEY G9	
	Hi4 PHEV	
Dimensions and Weight		
Length	mm	5,050
Width	mm	1,985
Height	mm	1,900
Kerb Weight	kg	2,803
Wheelbase	mm	3,085
Min Luggage Capacity	L	233
Max Luggage Capacity	L	1,725
Gross Vehicle Mass	kg	3,328
Ground Clearance	mm	155
Fuel Tank Capacity	L	58
Min Turning Radius	m	5.9
Seat Layout	Seats	7 (2+2+3)
Powertrain		
Powertrain	1.5L Inline 4-Cylinder Turbocharged Plug-in Hybrid Engine	
Drive Type	Intelligent Electronically Controlled All-wheel Drive (AWD)	
Combined Max Power	PS (kW)	442 (325)
Combined Max Torque	N.m	642
Engine and Transmission		
Engine Type	4-Cylinder 16 Valves with Turbocharged	
Injection Type	Petrol Direct Injection	
Engine Displacement	cc	1,499
Max Engine Power	PS (kW) / RPM	150 PS (110 kW) / 5,500-6,000
Max Engine Torque	N.m / RPM	240 N.m / 1,800-4,000
Transmission Type	4-Speed DHT (Dedicated Hybrid Transmission)	
Electric Motor and Battery		
Motor Type	Permanent-magnet Synchronous Motor	
Max Power of Front Electric Motor	kW	80
Max Torque of Front Electric Motor	N.m	170
Max Power of Rear Electric Motor	kW	135
Max Torque of Rear Electric Motor	N.m	232
Battery Type	Ternary Lithium Battery	
Battery Capacity	kWh	44.2
Driving Mode		
Power Mode	EV Mode / EV Priority Mode / Intelligent HEV Mode	
Driving Mode	Eco / Normal / Sport / Snow / AWD	
Performance		
0-100 km/h	s	5.7
Top Speed	km/h	190
Fuel Consumption (NEDC)	L/100km	1.2
Fuel Consumption at Low State of Charge	L/100km	6.2
Electric Driving Range (NEDC)	km	170
Combined Driving Range (NEDC)	km	1,000+
AC Max Charging Power	kW	6.6
DC Max Charging Power	kW	60
DC Charging Time (30% - 80%)	min	26
AC Charging Time (15% - 100%)	h	6.5
Vehicle-to-Load (V2L) External Power Supply	kW	3.3
Suspension System		
Front Suspension	McPherson Independent Suspension	
Rear Suspension	Multi-link Independent Suspension	
Frequency Response Damper (FRD)	•	
Brake System		
Front Brakes	Ventilated Disc	
Rear Brakes	Ventilated Disc	

Model	GWM WEY G9	
	Hi4 PHEV	
Tyres and Wheels		
Tyre Size	245 / 50 R18	
Wheel Size	18" Alloy	
Tyre Repair Kit	•	
Exterior Equipment		
Intelligent LED Headlamp	Auto Headlamp	•
	Auto High Beam	•
	Follow Me Home System	•
LED Daytime Running Light (DRL)	•	
LED Taillamps	•	
Rear LED Fog Lamp	•	
Electric Adjustable and Auto Folding Side Mirror with Turn Signals	•	
Front Boneless Wiper	•	
Hidden Rear Wiper	•	
Automatic Wipers	•	
Front Sunroof	•	
Rear Panoramic Sunroof	•	
Electronic Tailgate with Sensor	•	
Anti-theft Alarm System	•	
Seat Configurations		
Seat Materials	Premium Nappa Leather + Third Row Leatherette	
First Row	Driver Seat Electric Adjustment	8-way
	Driver Seat Electric Lumbar Support	4-way
	Driver Seat Memory and Welcome Function	•
	Driver Seat Massage System	10-point Massage
	Passenger Seat Electric Adjustment	6-way
	Passenger Seat BOSS Switch	•
	Passenger Seat Memory Function	•
	Driver and Passenger Seat Ventilation System	•
	Second and Third Row Flexible Common Rail System	•
	Middle Aisle	•
Second Row	Zero Gravity Seats	•
	Ventilation System	•
	Massage System	10-point Massage
	2-way Electric Leg Rest	•
	Electric Seat Adjustment	6-way
	Armrest	•
	Seat Occupant Sensor	•
	Seat Integrated Control Panel	•
	4-way Headrest	•
	Seatback Folding Tray Table	•
Third Row	ISOFIX	•
	TIP-UP Seats (4/6 Points)	•
	Manual Seat Adjustment	4-way
	Seatback with Steel Reinforcement	•
	ISOFIX	•
Interior Equipment		
Ambient Light	64 Colours with Breathing Effect	
Driver and First Row Passenger Sun Visors with Vanity Mirrors and LED Light	•	
Steering Wheel with Audio and Driving Information Controls	•	
4-way Adjustable Steering Column	•	
Electronic Parking Brake (EPB) with Automatic Vehicle Hold (AVH)	•	
Column Shifter	•	

Model	GWM WEY G9		
	Hi4 PHEV		
Convenience			
Digital Instrument Panel	12.3"		
Heads-Up Display (HUD)	•		
Wireless Charger	50 W		
Active Access and Walk Away System	•		
Speed Sensing Auto Door Lock	•		
Full Vehicle Voice Command	6 Zones		
Automatic Air Conditioning	3 Zones		
Air Quality Automatic Control System (AQSI) with Plasma	•		
CN95 Filter	•		
HALOSonic Active Noise Cancellation	•		
Double Opening Cold and Warm Refrigerator (0 - 50 °C)	12.5 L		
Full Vehicle Keyless Entry System	•		
Automatic Unlock After Power Off	•		
USB	First Row USB	2 USB-A + 1 USB-C	
	Second Row USB	2 USB-A + 2 USB-C	
	Third Row USB	2 USB-A + 2 USB-C	
12V Power Outlet	First Row and Luggage Compartment		
USB Power Port for Dashcams	•		
Auto Front Defogging System	•		
Entertainment			
Touch Screen Infotainment and Multimedia Display	14.6"		
Speakers	21		
Apple CarPlay™ and Android Auto™	Wireless		
VSC Adaptive Sound Compensation	•		
Bluetooth Hands-free Calling System	•		
Radio FM/AM	•		
Glass and Rearview Mirror			
Acoustic Windshield	•		
Acoustic First Row Door Glass	•		
Acoustic Second Row Door Glass	•		
Sunshades	Second and Third Row Windows		
Digital Rearview Mirror with Automatic Anti-glare Function	•		
Power Windows with Anti-pinch Function on All Doors + Auto-close Function	•		
Intelligent Mobile Application			
Monitoring via Application	Doors and Windows Status	•	
	Sunroof Status	•	
	Hybrid Power Status	•	
	Air Condition Status	•	
	Total Mileage / Electricity Level / Fuel Level	•	
	Tyre Temperature and Tyre Pressure Status	•	
	Charging Status	•	
	Battery Pack Active Insulation Status	•	
	Sliding Door Status	•	
	Vehicle Location	•	
	E-fence	•	
	Controlling via Application	Remote Vehicle Start / Stop	•
		Door Lock / Unlock	•
		Vehicle Locator: Horn / Flash / Horn + Flash	•
		Close Windows	•
Remote Sunroof Closing		•	
Air Condition On / Off		•	
Seat Ventilation On / Off		•	
Remote Front and Rear Defogging		•	

Model	GWM WEY G9	
	Hi4 PHEV	
Safety System and Intelligent Technology		
Airbags	6 Airbags (Front + Side + Curtain)	
Emergency Call (E-call)	•	
First Row Three-point Seat Belts with Double Pretensioners, CLT (Crash Lock Tongue), and Load-limiters	•	
Height-adjustable First Row Seat Belts	•	
Second Row Three-point Seat Belts with Pretensioners and Load-limiters	•	
Third Row Three-point Seat Belts	•	
Collapsible Energy-absorbing Steering Column	•	
360° Surrounding Camera	•	
Transparent Chassis Function	•	
Fully Automated Integrated Parking	•	
Anti-lock Braking System (ABS)	•	
Electronic Brakeforce Distribution (EBD)	•	
Traction Control System (TCS)	•	
Adaptive Cruise Control with Intelligent Cornering (Intelligent ACC)	•	
Traffic Jam Assist (TJA)	•	
Auto Emergency Braking + Intersection (AEBI)	•	
Front Collision Warning (FCW)	•	
Manoeuvre Emergency Braking (MEB)	•	
Lane Departure Warning (LDW)	•	
Lane Keeping Assist (LKA)	•	
Lane Center Keeping (LCK)	•	
Wisdom Dodge	•	
Emergency Lane Keeping (ELK)	•	
Lane Change Assistance (LCA)	•	
Rear Collision Warning (RCW)	•	
Rear Cross Traffic Alert (RCTA)	•	
Rear Cross Traffic Braking (RCTB)	•	
Traffic Sign Recognition (TSR) and Speed Alarm	•	
Speed Assist System (SAS)	•	
Second Collision Mitigation (SCM)	•	
Hill Start Assist (HSA)	•	
Hill Descent Control (HDC)	•	
Blind Spot Detection (BSD)	•	
Tyre Pressure Monitoring System (TPMS)	•	
Door Open Warning (DOW)	•	
Front and Rear Radar	6 points / 6 points	
Millimetre-wave Radar	2 points	
Emergency Signal System (ESS)	•	
Mechanical Child Safety Lock	•	
Event Data Recorder (EDR)	•	

Notice:

The specifications, product information, or images displayed herein are for illustration purposes only. Some of the product and service information, illustrations and images contained herein may have been prepared for generic use and the actual products may vary from those displayed herein, owing to technical limitations.

The illustrations may show accessories, optional equipment, or other features which are not part of the standard specification or service scope available in Malaysia, and the company reserves the right to change all information, specifications and illustrations without prior notice. For safety and efficiency in use, please refer to the manual before use. The company shall not be responsible for discrepancies or differences between the illustrations displayed in this specification and standard equipment and the actual product.